



4-H

Geology Project

***Collecting Rocks,
Minerals & Fossils***

Written by William Fountain, Extension Specialist in Horticulture, with assistance from Wendy Stivers, Extension Program Specialist for 4-H/Youth Development, and Patricia P. Schrader, former Extension Information Specialist.

Contents

Did You Ever Think about Being a Rock Hound?	2
Let's Go Back in Time... WAY Back	4
Geologic Time Clock (Noon to midnight on the 4th day)	5
The Difference in Minerals and Rocks Is ELEMENT-ary	7
Fossils, the Senior Citizens of Plants and Animals!	7
Thinking about Your Collection	11
Types of Rocks	12
Types of Minerals	17
Types of Fossils	18
Deciding What's What... Rock Identification	19
A Special Find... Crystals!	20
Rocks That Glow in the Dark... Fluorescence and Phosphorescence	22
So You Want to Do More... Advanced Activities	23
Putting It All Together... Displaying Your Collection	23
Exciting Places to Visit in Kentucky	25

Photographed by Bill Mesner, former Extension Information Specialist.

We wish to express sincere thanks to the Geology Department of the University of Kentucky for the generous help in the development of this publication.

We appreciate the loan of valuable specimens from personal and museum collections for photographing. To Dr. Lois J. Campbell, Dr. J. Gregory McHone, and Dr. Nicholas Rast, chairman of the Department of Geology, we are very grateful.

We are especially indebted to Dr. McHone who spent many hours reviewing various drafts of this geology project and who was always available to answer questions and provide expertise.

We also appreciate the help of agents, parents, and other helpful persons who reviewed the material and offered useful suggestions.

Did You Ever Think about Being a Rock Hound?

A what?? A rock hound. People who collect rocks often call themselves "rock hounds."

"But," you may be thinking to yourself, "I'm not interested in rocks... too dull for me."

Actually, the study of rocks (petrology), minerals (mineralogy), and fossils (paleontology) is fascinating and important.

Geology is the science that teaches the history of the earth, especially as recorded in rocks. Cave dwellers first became interested in the differences in the types of rocks when they discovered that the rock we now call flint made better arrowheads and tools than other types of rock. "O.K.," you say, "I can't argue with that. But we don't hunt our supper with a flint arrowhead these days. Rocks just aren't that important to us now."

Wrong! Let's look at this 4-H publication. It is made of paper held together by steel (a metal) staples. It was written on a computer that stored the information on a computer disk. The disk is made of plastic (from petroleum found by geologists) and has iron oxide (iron is a metal) on it. Computer chips are made of silicon dioxide (the mineral quartz).

This booklet was printed on a press made of metal. Some inks have metals or minerals in them to make them last longer or to give them unique colors. The booklet was stored in a metal building before it was delivered to your county. It was taken to your county in a metal truck that burned gasoline (a petroleum product) as it traveled over concrete (a rock product) and asphalt (a petroleum product) roads.

You may need glasses to read this publication. Glass, as with a computer chip, is made of silicon dioxide (quartz).

The light that helps you see this booklet uses electricity, made from burning coal or oil. Or perhaps uranium (a metal) was used to produce the electricity.

This list could go on and on. You might even want to see how far you can extend it. Rocks, it seems, are more important to us today than they were to the cave dwellers. This is why some people say we are still living in the "stone age."

Collecting rocks can be fun and will teach you about the history of the earth's past as well as what is happening today. Making a collection will help you become familiar with the different types of rocks and minerals that make up our planet. You don't even have to go far from your home or school to get started.

Rocks are so common that sometimes we often don't even notice them. The easiest places to look for rocks are along stream banks and road cuts. Later, you may want to take a field trip to other locations.

Kentucky has a large number of different types of rocks and minerals that will look beautiful in your collection. After you have been collecting for a while, you may decide to collect just one type of rock, such as fossils, ores (rock from which we get gold, iron, copper, lead, and other metals), or minerals.



A road cut, such as that shown above, is a history book you can't carry around with you.

Got Your Attention?

O.K., now that we have your attention, you may want to know a little more about this “rock hound” project.

First, this is a 4-H project. You don't have to be any special age to take geology, but it would be better to take this project after you have completed *Exploring Natural Resources*. In that project, you learn about all the systems that make up our environment. That project will make geology even more fascinating!

When you take this geology project, you can design your own plan. You (or your whole group) decide where you want to take field trips to see rock and fossil collections and who you want to speak at your group meetings. And you decide what you want in your collection and which specimens to put in your box for exhibit.

When you get into the study of geology and the collecting of rocks, you may want to do a geology project more than one year. Some people take geology for several years. You can plan your own project by setting goals for what you want to accomplish each year. You may want to do a study of the formation or mining of coal in Kentucky. Or you may want to do a

study on how continents were formed, on the glacial stages on earth, or on earthquakes or faults. There is no limit to the interesting topics of study you may choose. Then you can use these studies for giving speeches and demonstrations.

Remember: To enter your collection for state 4-H competition, you must follow the specifications in the state fair catalog. Your 4-H agent or leader can tell you about the rules.

Ready to start? This is what you will learn:

- The difference in minerals, fossils, and rocks.
- The types of minerals.
- The three main classes of rocks and how to identify them.
- How to clean your rocks and display them in a collection.
- The location of some good rock-collecting sites in Kentucky.

You may also:

- Take field trips.
- Enter your exhibit in 4-H competition.
- Give a talk or demonstration on your rock project.
- Do advanced geology work.
- Participate in leadership and citizenship activities.

Let's Go Back in Time... WAY Back

An Unusual Time Clock

Scientists tell us that the earth was formed about 4½ to 5 billion years ago. It is impossible for our minds to fully grasp such a long period of time. You can get an idea of just how long this is if you think of the earth as having been created in the first instant of a four-day period.

It was not until the very beginning of the third day that the most simple forms of life appeared. At noon on the fourth day, the first invertebrates (animals having no backbone) appeared. At 3 p.m., the first fish appeared in the oceans. Amphibians such as frogs and salamanders appeared at 5 p.m., and reptiles such as snakes, turtles, lizards and dinosaurs at 6 p.m.

The organic material that would form our fossil fuels (oil and coal) were formed between 6 and 10 p.m. The first mammals did not evolve until 9 p.m. It was not until 1¼ minutes before midnight at the end of the fourth day that human beings appeared (1 million years ago). We entered the 20th century 1/200 second before midnight, and the first man walked on the moon (1969) just 1/1000 of a second before midnight at the end of the fourth day!

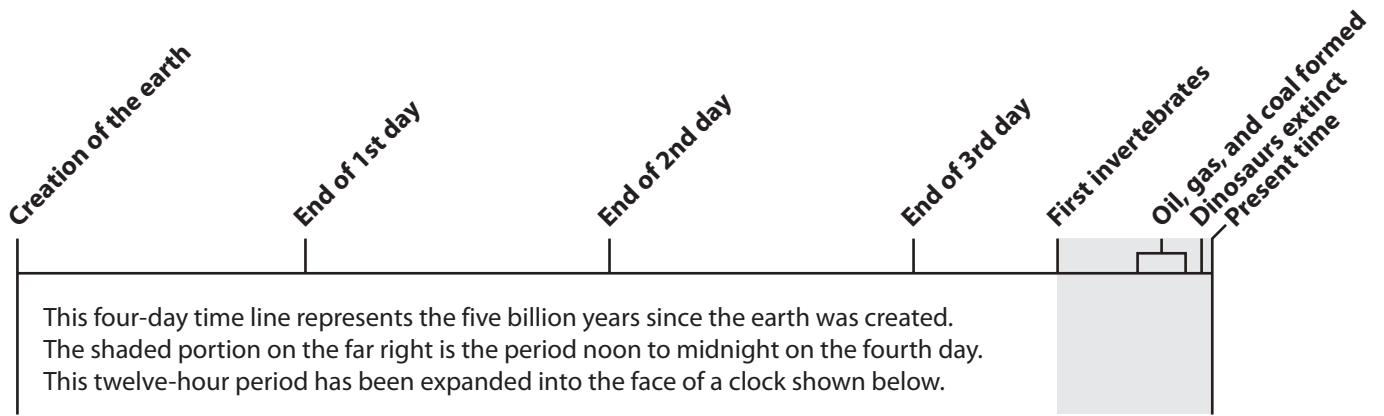

Geologic Time Clock

(Noon to midnight on the 4th day)

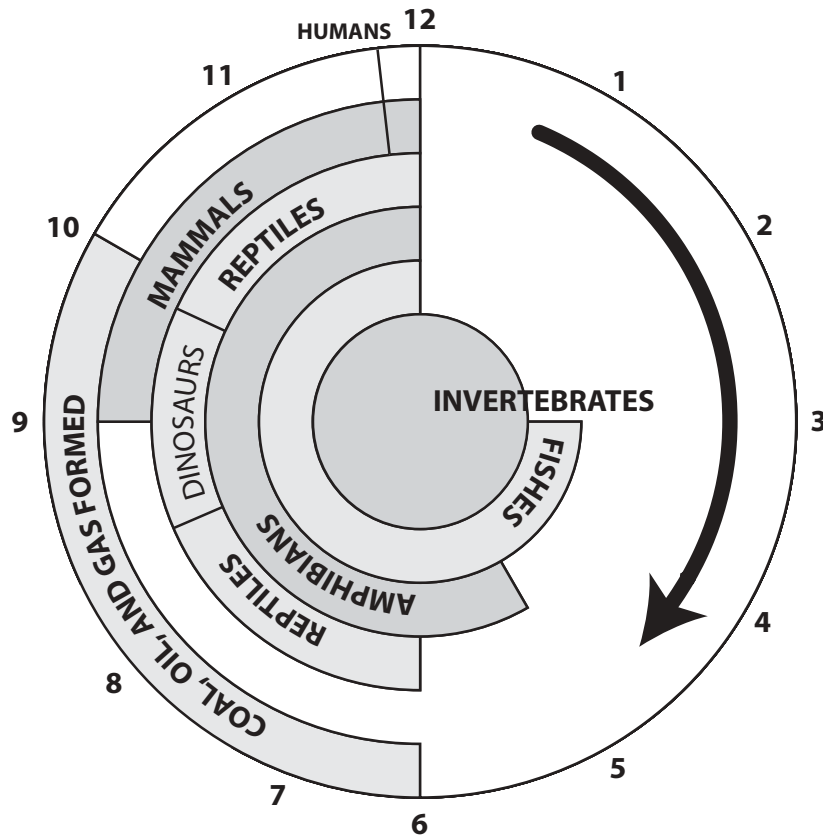

12 "hours" = 600 million years.
Humans appeared 1¼ minutes before midnight.

Activity

If one hour on the geologic clock is equal to 50 million years, can you figure out when Columbus discovered America? When the Declaration of Independence was written? At what point you were born?

The Radiation Theory

How do scientists know how old the earth is? They don't know for sure, but they do have a good way of estimating the earth's age—by measuring the radioactivity of the rocks found on earth.

The radiation theory seems to be quite accurate. Scientists know how much radiation an object such as a rock had at its beginning on earth. They also know how much and at what rate radioactivity is lost. So, the radiation theory divides the total radioactivity loss by the yearly loss, giving the age of the rock. It does not give the age of the earth, merely the age of the rock tested.

If scientists could find the oldest rock, they would, in theory, be able to tell the age of the earth. The oldest rock to date was found in Greenland. It has been determined to be 3.8 billion years old. Geologists believe that even older rocks once existed but have been worn away.

You can see that each rock is like a history book that may be many millions of years old. All you have to do is know how to read the book. The next time you are riding on an interstate highway, notice the change in colors and textures of the layers of a road cut from top to bottom. You might be seeing the end result of flash floods and dust storms, warm shallow lakes and glaciers, lush tropical forests and swamps, earthquakes, landslides, meteor storms, and animals grazing peacefully in a field of grass. And different "pages" of this history book may be within a few inches of each other.

The Geologic Time Scale

Geologic time is broken into three "eras," several suberas called "periods," and several subperiods called "epochs." The eras and periods are shown in the chart at right. Each era, period, or epoch relates to certain occurrences that were happening on earth at a certain time, such as the time of major glaciers, mountain building, etc.

Many of Kentucky's coalfields were formed during the Mississippian and Pennsylvanian periods. And much of Kentucky's "black shale" dates to the Devonian Period, while its limestone and fossils date to the Ordovician Period.

If you are interested in the breakdown of periods into epochs, you can find information in specific reference books on fossils and geology or in encyclopedias.

You may also want to study the various forms of life that existed in each era, especially if you are interested in a fossil collection.

CENOZOIC ERA

Period	Years Ago
Quaternary	1½ million
Tertiary	66 million

MESOZOIC ERA

Period	Years Ago
Cretaceous	144 million
Jurassic	208 million
Triassic	245 million

PALEOZOIC ERA

Period	Years Ago
Permian	286 million
Pennsylvanian	320 million
Mississippian	360 million
Devonian	408 million
Silurian	438 million
Ordovician	505 million
Cambrian	570 million

PRECAMBRIAN: More than 80 percent of the earth's estimated 4.5 to 5 billion years falls within this era.

NOTE: This chart is based on scientific evidence and is sometimes revised. Since there were no human beings to record the ancient information, revisions are made as new measurements are made.



Road cuts such as this one provide an opportunity to see the different layers of weathered materials that have been deposited over millions of years.

The Difference in Minerals and Rocks Is ELEMENT-ary

The earth we live on is a ball of rock 7,927 miles in diameter. It weighs 6.6 sextillion tons. While most of our knowledge of the inner part of the earth is limited to an area about 15 miles deep, scientists are developing new methods to study the earth at a greater depth. Nearly 98 percent of the earth's crust is made up of eight known elements: oxygen, silicon, aluminum, iron, calcium, sodium, potassium, and magnesium.

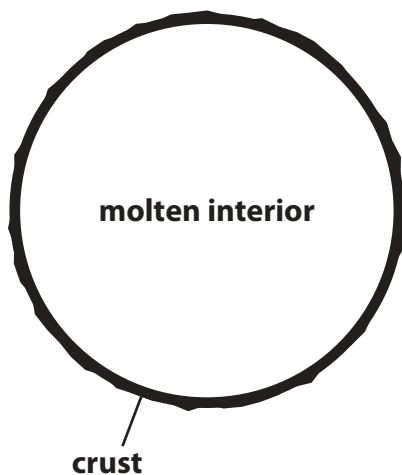

Minerals

Minerals are made up of one or more elements. Elements differ according to the number of atomic particles they contain. There are 102 known natural elements on earth; only about 20 of them are found in a pure, or natural, state. Minerals have never lived as animals or plants; they are inorganic. They are relatively pure substances that can be named by a definite chemical formula.

Some examples of minerals include salt, iron, sulfur, gold, and silicon dioxide (white sand). Minerals have definite physical



Crystals always have smooth, flat sides called faces.

properties such as crystal shape, cleavage, color, streak (hardness), taste, smell, and feel. All minerals are solid. (The word "mineral" is also used outside of science to include coal, oil water, gas, and related resources; however, these are not strictly minerals.)

There are about 60 types of minerals found in our state. However, more than half of these are not commonly found or are found as small pieces mixed in with other minerals. Coal and oil are often called "mineral resources," but they are not really minerals because they were once animals and plants. They are organic, and minerals are inorganic.

Minerals are often found in crystal form. Crystals are usually made up of fairly pure material and may look polished. They always have smooth flat sides called "faces." You have probably seen quartz, a mineral, that is long and has six sides. Often, it comes to a point. This is an example of a crystal.

Rocks

Rock is the solid mass that makes up much of the earth's crust. Rocks, like minerals, have never been alive. They are different from minerals in that they are not pure (uniformly the same material). Rocks are made of a mixture of minerals. Many times you can look at a rock and see the different minerals.

Granite is a good example of a rock in which the different minerals are visible. It is always made up of quartz, mica, and feldspar but may also contain other minerals. In some rocks, different mineral pieces are so small that it is difficult to see them. You have probably seen polished slabs of granite used as monuments or as building materials.



Fossils, the Senior Citizens of Plants and Animals!

Fossils are fascinating! Found in rocks, they offer a clue to the age of the rock and the kind of prehistoric life found on earth. The older the rock, the simpler the plant and animal fossils it contains.

Fossils are any type of life forms that have been preserved since the time they lived—thousands of years ago. Today we know that these creatures lived where their fossil remains are found. Many animals, such as clams, sea snails, and certain fish, live only in the sea. So, whenever fossils of this type are found, we know that the sea once covered that area. It is not uncommon to find fossils of fish that lived millions of years ago in the mountains of Wyoming, more than 1,000 miles from the sea.

Fossils are found in nearly every part of Kentucky. Tusks, teeth, and other bones of prehistoric animals have been found in the gravel pits of northern Kentucky. These animal remains were deposited in the area during the glacial periods. Fossils of mastodons have been found in the Green River valley and in Magoffin County. Giant beaver fossils, as well as tree and plant fossils, have been found in Eastern Kentucky.

Fossils also tell us what the climate was like thousands, or even millions, of years ago. If you find a fossil of an ancient crocodile, you know that the area where you found it was once a swamp and the climate was quite warm. We know this because crocodiles need that type of environment to survive.

Did you know that coal seams have been found in Antarctica? Coal is formed from ancient plant life, which has been squeezed by tremendous pressure. This means that tropical plants once grew where now there is only ice and snow.

Fossils also help in the search for oil. Geologists think that oil was formed when small creatures, usually in the sea, died and fell to the bottom, forming layers. When enough of these creatures piled up, the weight of the top layers squeezed the oils from those below. The oil then moved to rocks that had spaces to hold it—much like a sponge holds water. Over a period of time, the oil ran together, forming the oil deposits of today. Coral deposits are examples of this process. We look for coral in limestone deposits as indicators of oil traps.

Other fossils are used to indicate the temperature and pressure of rocks that allow oil to form. If it is too hot, the oil will disintegrate; if it is too cool, the oil will not form.

There are several ways in which animals and plants can be preserved into fossils:

Actual Preservation

Sometimes animals that had hard shells or bones became fossils but did not turn to stone. They remained the same as they did in life. This process is called “actual preservation.” There are three major ways in which this can happen: (1) freezing, (2) drying, and (3) in tar or peat bogs.



This fossil fern from the Pennsylvanian Period about 280 million years ago has been cleaned, dried, and shellacked to protect its surface.



This is the fossilized tooth of a mastodon, a large prehistoric elephant. Compare the size to the human bicuspid in the righthand corner.

Freezing. Freezing is fairly uncommon but it is the best method of preservation. In Siberia, Russia, mammoths (prehistoric elephants) have been found

completely preserved, just like meat in a freezer. The skin, hair, and tusks were preserved just as they were in life. Some people have even eaten this meat!

Drying. This is another type of actual preservation. Some animals, in hot climates where there is little moisture, dried in the sun after death. They have been preserved much like mummies.

Tar or peat bogs. The last type of actual preservation occurred in tar or peat bogs. Plant and animal life left in these places sank to the bottom. They were surrounded by a thick, gooey substance that did not allow the air to get in. Because decay bacteria cannot live in this environment, no decay took place.

Permineralization

Don't be afraid of this big word! It is just a term to describe another process by which fossils were formed. Sometimes a plant or animal died in an area where water, carrying dissolved minerals, soaked into its surface. When the water evaporated, the minerals were left and then hardened. In most cases, this type of fossilization will be hollow.

If the minerals soaked into cavities such as air pockets left in bones when the marrow decayed, the partially preserved remains also have been permineralized.

Replacement

Most petrified wood is an example of replacement. In this process, a tree died and was covered by a landslide of earth, lava, or water. As it began to decay, a molecule of wood rotted and was replaced by a molecule of mineral. By this process, every grain and wood fiber was turned to stone and today can be seen just as it could when it was wood.

Only a scientist with years of experience can tell what type of wood it was. It is important to remember this when you find petrified wood. Don't confuse its color with the color of present-day

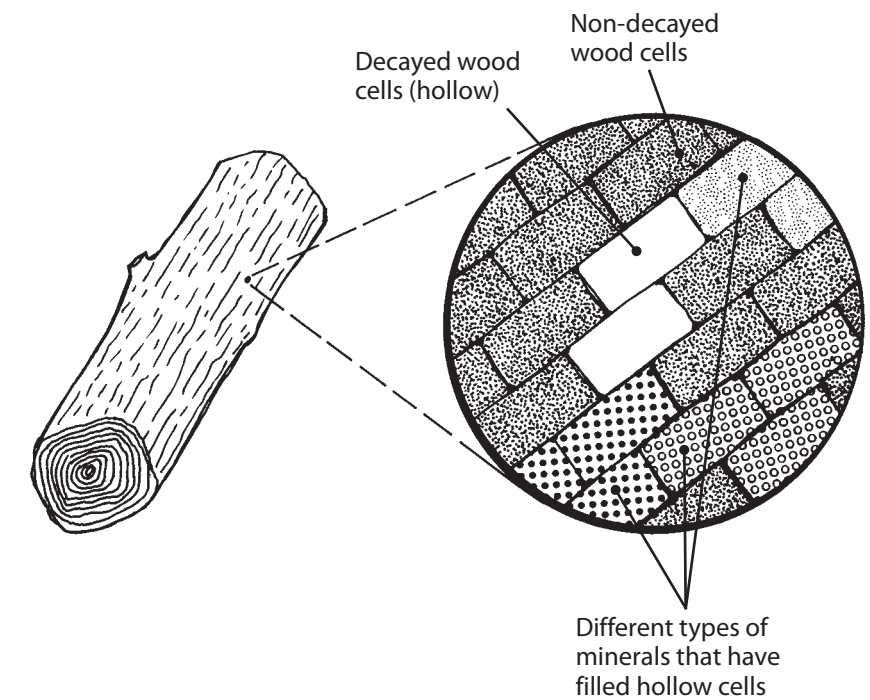

wood. In Arizona, bright blue, yellow, and red petrified wood has been found. Because wood does not grow in these colors, we know that the color of the fossil was caused by the mineral that replaced the wood. If a green mineral takes the place of the rotting wood, the petrified wood will be green. Most petrified wood is actually agate, which is used as a gemstone.

warm in that area. Fir and spruce tree fossils, normally found in cool climates, have been found in the tropics. This would indicate that the weather there was cool at one time.

Carbonization

Coal is an example of carbonization. In this process, the fossil is turned to what is known as "carbon." Plants die, falling into a swamp. More plants die and fall on top until, finally, the plants on the bottom are squeezed into what we know as coal.

Fossils tell us something of the early climate of an area. Coral found in rocks as far north as Greenland lead us to believe that the climate at one time was

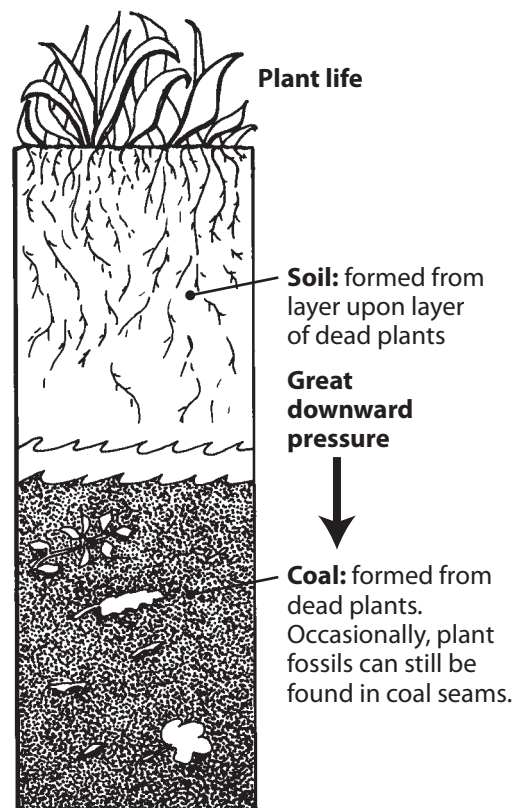

This agate fossil is a section of a tree stump. It was fossilized through the "replacement" process in which silica in ground water has replaced wood.



Traces or Trace Fossils

The last type of fossilization is the process that leaves "traces." These are not the actual remains of the living parts of either plants or animals but are traces left by them. This occurs when an animal or plant is trapped in mud that later hardens, leaving a mold. This process is much like making a mold for plaster. First you carve out a shape (mold) and then pour in plaster. You then have the cast of plaster when it dries. What comes out of such a mold is sometimes called a "concretion."

An example would be footprints left by dinosaurs. In some parts of the country, footprints of these creatures, which walked the earth

over 65 million years ago, have turned to stone. These footprints may be almost as large as a bathtub. Prints left by one of these huge animals were not actually a part of the animal when it was alive but a trace of its travels.

Another example of a trace is a "gastrolith" (a stone found in the stomach). Have you ever seen chickens pecking and swallowing little stones? They do this because they have no teeth and cannot chew their food. To be able to break down their food, they swallow sharp rocks to "chew" it for them. Paleontologists (scientists who work with fossils) have found some of these rounded stones along with the bones of dinosaurs.

Worm holes or feeding trails preserved in ancient sea-floor mud are common trace fossils found in Kentucky. These are sometimes found in intricate spiral patterns.

There are fossils of many kinds of animals and plants no longer living on earth. There were dragonflies with two-foot wingspans, gigantic elephants with long straggly hair and ferns the size of trees.





Although brachiopods were one of the earliest forms of life, they still exist today. Clusters of fossils such as this are commonly found in limestone. They are molds of the brachiopod shells.

Thinking about Your Collection

When you begin to collect rocks, minerals, or fossils, it is important to remember that you are putting together a collection of samples. You need not bring home the whole mountain, just pieces of the different types of rocks that make up the mountain!

If a rock is bigger than your fist, trim it down or do not bring it home. It is easier to display 15 rocks the size of a walnut than 15 the size of a basketball! If all the samples are about the same size, the collection will appear much neater. Some of the nicest looking collections are called “thumbnail” collections—where all of the samples are about a cubic inch in size. (Do not, of course, trim spectacular, large mineral samples or fossils; keep these as you find them.)

Equipment You Will Need

You will need a pack or bag in which to carry your samples home. If you think there is a chance you will be visiting several places or collecting more than one type of rock, it is a good idea to bring a pencil and some index cards for making notes. (You should write down the date, where you found the rock, what type of rock you think it might be, plants or other rocks in the area, and any other information that will be of help or interest later. Also, number each rock as you pick it up. Then place the card with the rock and wrap them both in newspaper.)

Other equipment you may want to invest in are a geologist’s pick or brickmason’s hammer for breaking rocks (a carpenter’s hammer is too brittle), goggles to protect your eyes, a cold chisel for cutting rocks, and a pair of heavy gloves to protect your hands.

You will also need comfortable walking shoes, a magnifying glass for examining rocks, a pocketknife and, very importantly, a canteen of water and a snack.

Check off these items as you prepare for your field trip:

- Bag
- Index cards
- Pencils
- Newspapers
- Geologist’s pick or brickmason’s hammer
- Goggles
- Cold chisel
- Heavy gloves
- Comfortable walking shoes
- Magnifying glass
- Pocketknife
- Canteen of water
- Snack



Some Rules of Collecting

Many of the places with interesting rock formations are on private property. **It is always important to get permission from the owner before going on private property.**

Mine dumps and quarries are excellent places to collect rocks, but most owners will require someone to go with you for your own safety. You should never enter an abandoned mine without an adult along who knows that the mine is safe. Many abandoned mines have poisonous gases in them or may be in danger of caving in.

Very few people will object to you collecting a few rocks from their property. What they do not want is someone who will leave litter, write on rock walls, or damage trees or rare rock formations. After you are through collecting, it is a good idea to stop and thank the property owners and tell them what you saw and learned.

In addition to collecting your own rocks, you may want to trade with other collectors. Also, there are a large number of rock shops around the country where you can buy rocks. Make a habit of looking for these places in the telephone book when you are out of town visiting friends or relatives.

Cleaning Your Rocks

Once you have returned home, clean your rocks with warm water and a soft brush. After they are clean, let them dry. Then look at your samples again. Keep only those that will improve your collection, unless you plan to trade rocks with someone else.

Place a spot of white enamel paint about half the size of a dime on the rock. The smaller the rock, the smaller the spot will have to be. After the paint is dry, write the number on the spot with a black pen. Remember to number your rocks according to the order in

which you find them. Be sure this same number is on the card you will keep in a file box. Record everything you know about this specimen on the card.

In addition to the date and where the rock was found, you may want to record what types of plants were growing in the area, the type of rock, and its chemical composition. Write this down; don't trust your memory.

Types of Rocks

Whoa! Hold it. By now you must be thinking to yourself: "How can I write down the type of rock and its chemical composition? I don't even know them."

Rocks are divided into three different types: **igneous**, **sedimentary**, and **metamorphic**. What makes these three groups different is how they were formed. Most rock collections will be divided into these three groups.

Igneous

The interior of the earth is very, very hot—hot enough, in fact, to melt rock—and melted rock is just what is down there. Sometimes this melted rock works its way up to the surface and forms a volcano. If it gets close to the water table, a hot spring or a geyser will occur. How fast and where this rock cools and what it was made of determine what type of igneous rock forms. Rocks that cooled off below the earth's surface are known as "intrusive"; rocks that reached the earth's surface before they cooled off are called "extrusive."

Granite and basalt are igneous rocks that cooled slowly enough to form large crystals. Granite is usually light-colored, although it may be pinkish red or black-spotted. Basalt is a fine-grained, dark rock. It is mined, crushed, and sold as "traprock," which is used for railroad beds. Obsidian, which is black volcanic glass, cooled so fast that it did not form crystals. Obsidian was highly prized by the American Indians for making arrowheads.

The lava that rose to the surface also cooled so fast that it did not form crystals. In rocks that do form crystals, you can see how relatively fast they cooled. The more slowly the rock cooled, the larger and better defined the crystals.

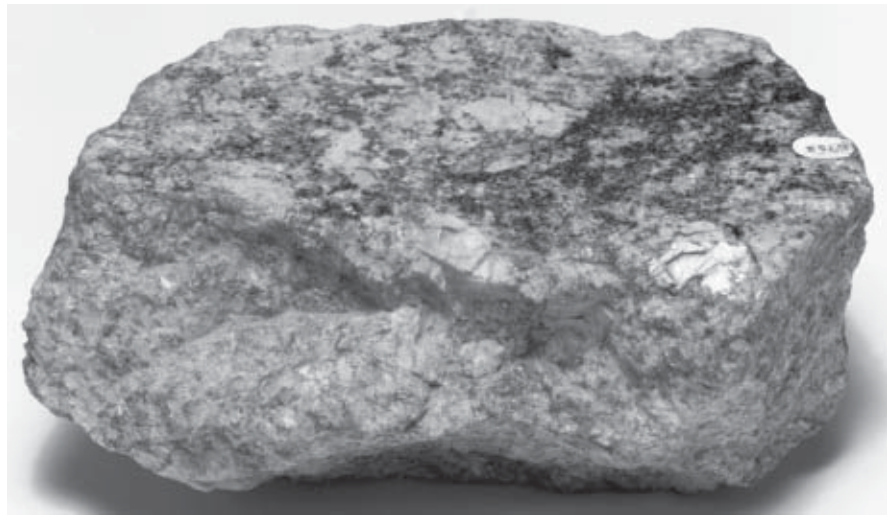

Granite is an igneous rock that was formed by slow-moving melted rock working its way up through the surface of the earth. It is called "intrusive" because it cooled off before it actually reached the earth's surface.

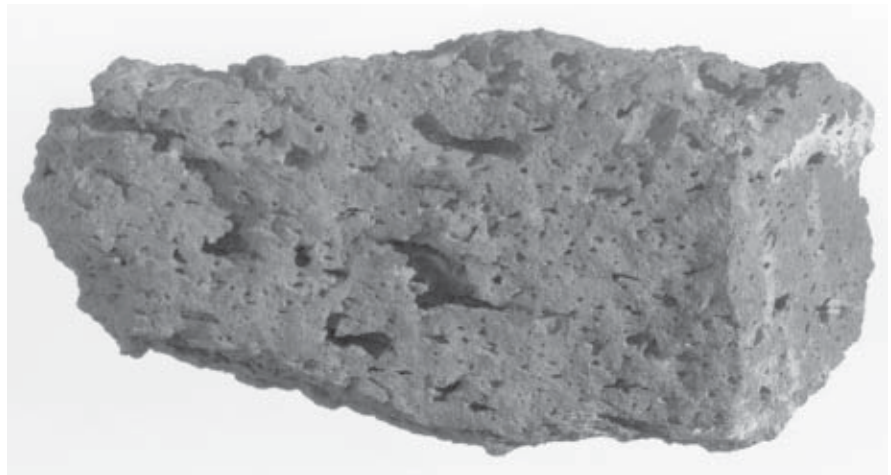

Basalt, like granite, was melted rock, but it cooled rapidly as it flowed out onto the surface of the earth. It is "extrusive" rock. Black and "clinkerlike," basalt is used for railroad beds.

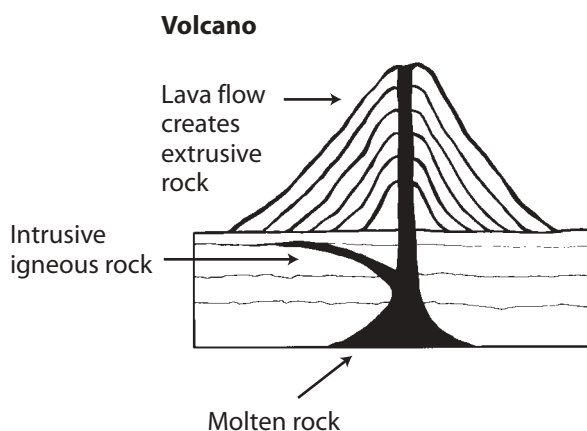

Large areas of land in some western states are covered by lava. There is some evidence of volcanic activity in far Western Kentucky, near Illinois, and possibly in Elliot County. The formation in Elliott County is similar in composition to that which produced diamonds in South Africa. Over hundreds of millions of years, these rocks have weathered so much that they are no longer recognized as lava.

Simplified Classification of Igneous Rocks*

Texture or grain size	Light Colored. Principal minerals: orthoclase feldspar, some biotite, or amphibole		Intermediate. Principal minerals: plagioclase and orthoclase feldspar, amphibole, biotite, pyroxene		Dark Colored. Plagioclase feldspar, pyroxene, amphibole, olivine
	With quartz	No quartz	With quartz	No quartz	
Very coarse-grained	Pegmatite				
Coarse- to medium-grained	Granite	Syenite Phonolite (1)	Granodiorite Quartz diorite	Diorite	Gabbro Pyroxenite (<i>pyroxene only</i>) Peridotite
Fine-grained (2)	Rhyolite	Trachyte	Dacite	Andesite	Basalt
Porous	Pumice		Pumice		Scoria
Glassy	Obsidian				
Fragmental or broken	Fine-grained; ash or tuff Coarse-grained; breccia or agglomerate				

* You will not find igneous specimens on field trips in Kentucky. You may purchase them from rock shops.

Activity

Research volcanoes in the United States. Find pictures and articles about the last volcano to erupt in the United States. Find out which state has volcanoes that erupt frequently.

Sedimentary

Once there was nothing on earth but igneous rocks. Then heat, cold, wind, water, and the movement within the earth slowly began to break some of these rocks into smaller and smaller pieces. These bits of dust, sand, and small rocks began to collect in low spots and build up in deeper and deeper layers. With time, pressure, and natural cements, they were once again bound together as sedimentary rock. This process is still going on today.

There are many types of sedimentary rocks found in Kentucky. Some of these contain fossils; this tells us that Kentucky was once under a large, warm, shallow sea. Some sedimentary rocks common in Kentucky:

- **Sandstone**, made from sand
- **Shale**, made from mud

- **Conglomerate**, pebbles in another type of sedimentary rock
- **Limestone**, which is made from shells or calcium carbonate (lime) deposited in the sea.

Coal, oil, and gas are often found in layers within sedimentary rocks. (All three of these are found in Kentucky.) If you see a layer of shale with a layer of coal on top, then another layer of shale, then a layer of sandstone, you can tell a lot about what the area was like millions of years ago. First there was a muddy lake or sea that formed the layer of shale. Then plants, which would form the layer of coal, began to grow. Then the area again became a muddy lake, forming a layer of shale. Finally, the water became clear as the sand was deposited, possibly along an ancient seashore.

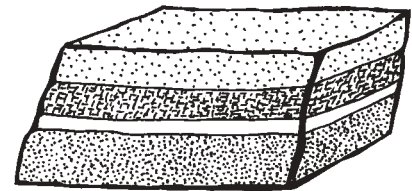

Sandstone showing different layers



Shale

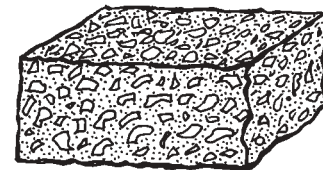

Conglomerate

Simplified Classification of Sedimentary Rocks

Texture or Grain Size	Chief Mineral	Cement (matrix)	Rock Name
1/16 inch or greater in a groundmass of 1/16 inch	Fragments can be any mineral or rock type	Silica, calcite, clay, iron oxide, etc.	Breccia (<i>angular fragments</i>) Conglomerate (<i>rounded fragments</i>)
1/16 inch or less	Quartz	Silica, calcite, iron oxide, etc.	Sandstone
	Calcite	Calcite	Limestone
	Dolomite	Dolomite	Dolomite
Dense (<i>cannot be seen with naked eye</i>)	Gypsum	Gypsum	Gypsum
	Clay	Clay	Shale
	Quartz or silica	Quartz or silica	Chert

Did You Know?

- That the presence of large deposits of limestone near the surface is one of the major reasons that Kentucky developed a large horse industry? It was thought that horses would have stronger bones due to the calcium in the water.
- That the same conditions that produced coal were also capable of producing diamonds, which are pure carbon changed to crystals under great heat and pressure? Although geologists have never found any, some people think there may be diamonds in Elliott and Morgan counties.
- What a "salt lick" is? Millions of years ago as the warm shallow seas that covered Kentucky dried up, the salt was left behind as a deposit. Much later underground streams worked their way through these deposits, picking up small amounts of salt in the process. When this water came to the surface as springs, it was slightly salty. These places became known as "licks" because animals would travel long distances to them for the salt. Early settlers boiled the water down for the salty deposit and used it to preserve meat.



This "banded" sandstone, a sedimentary rock, is similar to those found near Somerset, Kentucky. The bands show clearly the tightly cemented layers of sediment that form the solid rock.

Activity

1. Look at a piece of coal. Can you see its layers?
2. Do a little research and find out what processes took place inside the earth that caused the formation of Mammoth Cave.

Metamorphic

Metamorphic means “changed form.” If sedimentary or igneous rocks are exposed to heat and pressure, they will become metamorphic—a different type of rock. If there is enough heat to melt the rock, it will again become an igneous rock.

Metamorphic rocks sometimes keep the layers or banding that they had as sedimentary rocks. Igneous rocks will not. Sometimes these layers are very wavy due to the extreme pressure that was put on the rock. Some metamorphic rocks are slate (made from shale), quartzite (made from sandstone) and marble (made from limestone). There are no metamorphic rocks in Kentucky.

The geology of the earth is always changing. New rocks are not being made, but many of the old ones are being changed from one type to another. As you are out collecting rocks, watch for indications that rocks are being broken down.

All of our soil was once rock. Plants growing in soil make weak acids that will break down rocks

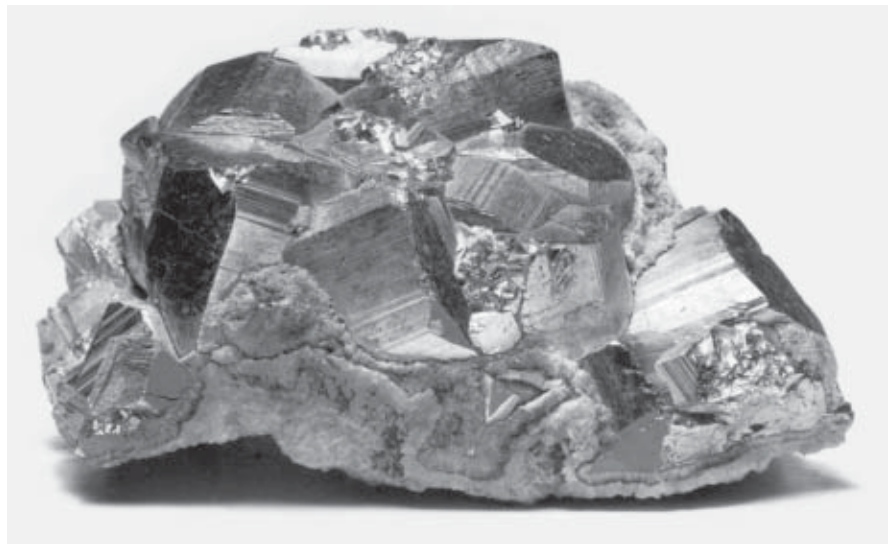

Pyrite is a yellow metallic mineral sometimes called “fool’s gold.” It is an example of a metamorphic rock mineral. Pyrite is a common source of sulfur.

even more. A seed may fall into a crack in a rock. As the plant grows, the stem gets larger, causing the crack to get larger, producing particles of sand and dust.

You will often see a sandy area left at the bottom of a cliff as a result of wind and water erosion. This sand may be washed into a stream and, after a while, into the ocean where, after several million years, it will become sandstone.

Activity

Do a little research and find out what natural event occurred in 1811 and 1812 that resulted in the formation of Reelfoot Lake. When the ground sank, where did it go? What changes in pressure and temperature occurred in the rocks below the surface? Could there also have been some folding in the rock formations?

Simplified Classification of Metamorphic Rocks*

Texture or Grain Size	Principal Mineral(s)	Rock Name	Original Rock Type
Equigranular (<i>equal grain size</i>)	Quartz	Quartzite	Sandstone
Equigranular to foliated	Calcite and/or dolomite	Marble	Limestone and/or dolomite
Broadly foliated (<i>parallel layers or bands</i>)	Feldspar, mica, amphibole, quartz, garnet, etc.	Gneiss	Granite, rhyolite, shale, etc.
Thinly foliated	Feldspar, mica, amphibole, quartz, etc.	Schist	Andesite, basalt, rhyolite, shale, etc.
Very thinly foliated	Mica, quartz, clay, (<i>these minerals normally cannot be seen with the naked eye</i>)	Slate (1)	Shale

* You will not find metamorphic rocks on field trips in Kentucky. You may purchase them from rock shops.

Types of Minerals

There are more than 1,100 different types of minerals on the earth. Some minerals are very common and others are very rare, but all of them can be put into one of the three groups: **metallic minerals**, **nonmetallic minerals**, and **rock-forming minerals**.

Metallic Minerals

Metallic minerals or metals are the ones we use most often. Some of the common ones contain silver, copper, mercury, iron, nickel, lead, and zinc. Most of the metals are found, along with other things, in rocks called ores. Ores were often formed into thin sheets, called veins, that ran through other rocks. Often the veins were formed when water carrying dissolved minerals seeped into cracks and, over thousands of years, were slowly deposited until the crack was completely filled. At other times, the veins resulted when hot, gaseous materials seeped into cracks and hardened into veins as they cooled.



Native Copper

Every metal has a different melting point and a different specific gravity. (See p. 19 for more information on specific gravity.) When ore is heated slowly to very high temperatures, the different minerals it contains will begin to melt out at different times. Minerals that have a lower specific gravity will float on the heavier minerals.

Metals are unique. They will conduct electricity; they are ductile (*can be drawn out into a wire*); they are malleable (*can be hammered*

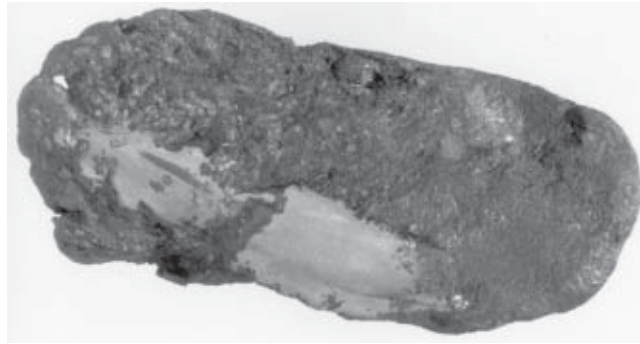

Native copper usually crystallizes into a more twisted, wirelike mass than this piece. This specimen has been partially polished to make an attractive paperweight. Copper is a metallic mineral.

into thin sheets); and most are shiny when their surface is smooth.

Some metals can be mixed together to make a new metal, which is harder than either of the pure metals. For example, bronze—a mixture of copper and tin—is harder than either pure copper or pure tin.

The study of these and other facts about metals is called metallurgy.

Nonmetallic Minerals

Nonmetallic minerals contain other important materials such as sulfur, graphite (*the lead in pencils*), gypsum, salt, borax, talc, asbestos, and quartz. These materials are important as building materials and in the chemical industry. Sulfur is used as a drug, and salt is important in our diet. Glass is made from quartz, borax is used in cleaning products, and talc is used as powder.

Most industries could not operate without nonmetallic minerals of some sort.

Rock-Forming Minerals

Rock-forming minerals are said to be the building materials of the earth. They form our mountains, valleys, and soils. Most of these minerals contain silicon and oxygen. The micas are in this group. Another rock-forming mineral is the calcite group, which includes limestone, marble, and chalk. Building materials such as concrete are made with crushed limestone.

It does not take long to see how important rocks and minerals are to our existence. You can also see how many different jobs are related to the study of rocks and minerals. Even if you do not choose to make geology or one of the related studies your lifelong work, this project can help you develop a very enjoyable hobby and at the same time have fun in 4-H.



Asbestos



Quartz



Sulfur

Activity

Geology identification

contests are fun and will help you learn the common rocks and minerals of Kentucky and important rocks and minerals from other areas. Contests can be done in different ways: between individuals, between two different teams in your club, or between clubs. Contests on other geology subjects are just as much fun. So choose sides and look at the suggested scoring method:

5 points: *correct name and class or group*

Name: Basalt
Class: Igneous

3 points: *correct name only*

Name: Basalt
Class: ??

2 points: *correct class or group only*

Name: ??
Class: Igneous

1 point off: *each misspelled word*

Name: Besalt
Class: Ineous (-2 points)

0 points: *incorrect names or those that are left blank or can't be read*

Name: ??
Class: ??

Types of Fossils

Fossils have a greater interest for the general public than any other part of geology. Perhaps it is because of our natural curiosity about the past. Fossils are the remains of prehistoric plant and animal life on earth. They are also evidence that this life once existed. Fossils, like rocks and minerals, are divided into different groups.

Most fossils are the result of hard parts of a living thing, such as bone, shell, or wood, that were left behind when the living creature died. It is only in very rare cases that an entire animal has been preserved. The hard parts are often found in an almost original condition. In other cases, the individual cells have been replaced by dissolved minerals.

The soft parts, such as skin, leaves, and insects, are rarely found intact. Most of the fossil

Common Fossils

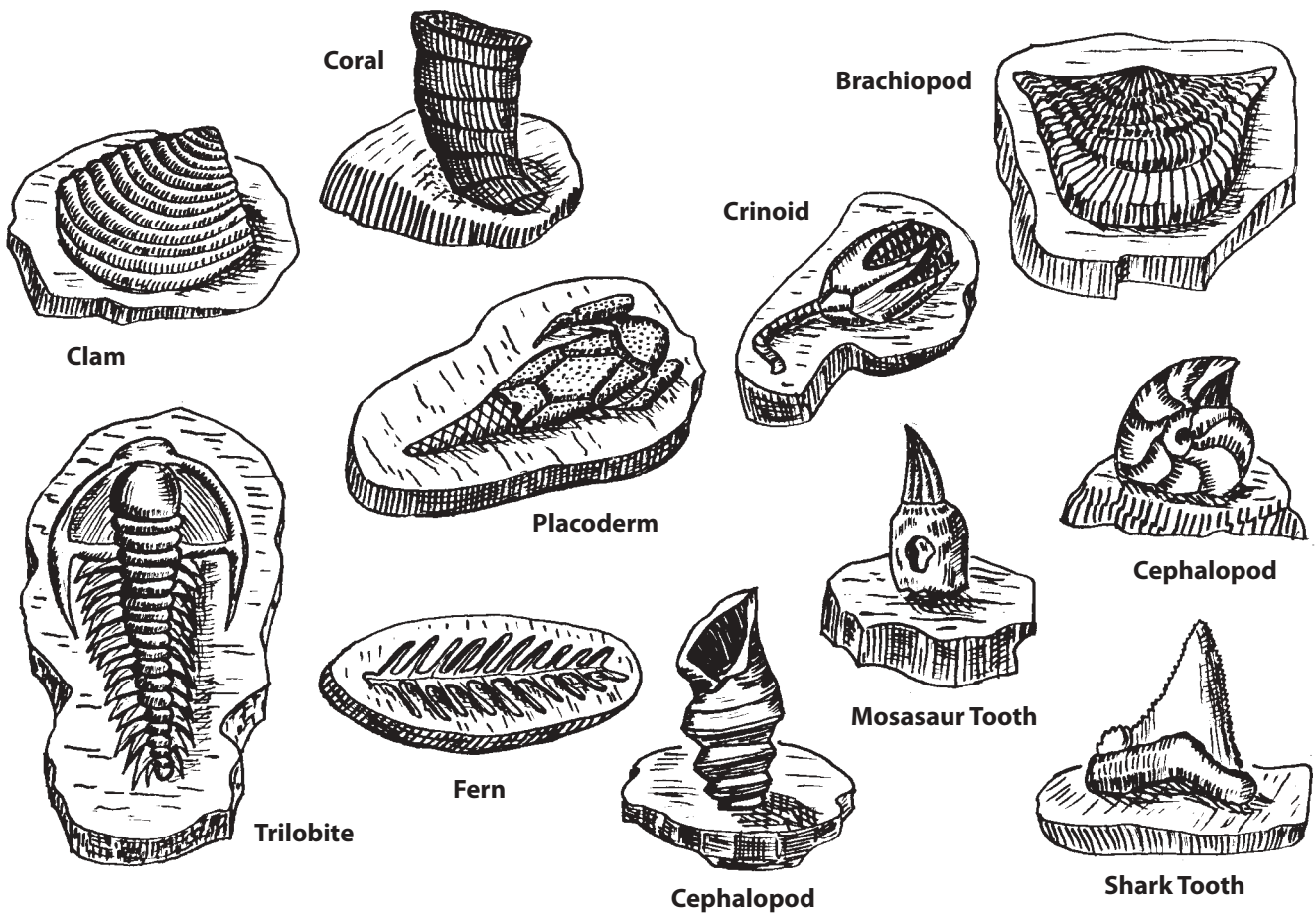

records we have of these specimens are in the form of molds and casts where the part was pressed into soft mud or sand.

Molds and casts are also the way we find the most evidence that a certain type of life existed.

Examples include the tracks of animals and borings of mollusks (shellfish) and worms. There are even examples of petrified wood and shells with borings. You might say that these are fossils within a fossil. Other examples of evidence include fossil excreta and gastroliths, smooth rounded pebbles that aided the digestive process of dinosaurs.

Deciding What's What... Rock Identification

The task of identifying a rock you have collected can be made much easier if you follow a few simple steps.

The first decision to be made is whether the rock is igneous, sedimentary, or metamorphic. A good clue can be found at the collection site by looking at nearby rocks you can already identify. Another big help will be your 4-H leader and friends who also collect rocks.

Always consult a good reference book (*found at any good bookstore*) if you are not sure about a particular rock. It will tell you how your specimen should react to the following tests.

Color

The color of a rock is one of the best ways to tell what type it is. Since weathering will sometimes change the color of the surface, you should make sure there is a fresh surface to examine.

Sometimes a rock will have different colors if there are different minerals mixed with it. What your eyes tell you about a rock is called **field identification**.

Hardness

Each rock or mineral has a certain hardness that is unique to that particular type. Each mineral will scratch a softer mineral and, in turn, will be scratched by a harder mineral. For example, gypsum will scratch talc, and calcite will scratch gypsum, but talc will scratch neither gypsum nor calcite. (*Because weathering will affect the hardness of a mineral, it is important to make the test on a fresh surface.*)

There is a list of common minerals, called **Mohs scale**, that arranges minerals in order of their hardness. Having this scale will help you in identifying minerals by determining their hardness.

1. Talc (SOFTTEST)
2. Gypsum
3. Calcite
4. Fluorite
5. Apatite
6. Orthoclase
7. Quartz
8. Topaz
9. Corundum
10. Diamond (HARDEST)

You are not likely to find any rocks or minerals in Kentucky with a hardness greater than 7. The following list has some common objects that will help you decide the hardness of your specimen. For example, if you can scratch the specimen with a penny but not your fingernail, the hardness of the specimen will be between 2½ and 3½. You can look up the hardness of rocks and minerals in some of the reference books listed in this publication.

FINGERNAIL	up to 2.5
PENNY	2.5 to 3.5
KNIFE BLADE	up to 5.5
WINDOW GLASS	5.5
STEEL FILE	up to 7.0

Streak

The streak of a mineral can also be a valuable clue to its identity. The streak is the color of the powder that is left when the mineral is rubbed across an unglazed porcelain plate. (*The back of an old piece of bathroom tile makes an excellent streak plate.*)

The color of a mineral may vary, but the color of the streak is generally constant. The streak may be the same color as the mineral, or it may be entirely different. This is especially useful for minerals that look metallic. The streak of white mineral is always white.

A good reference book can help you identify minerals by their streak colors.

Specific Gravity

The specific gravity of a mineral is another test that can help you identify an unknown specimen. Specific gravity is the comparison of the weight of the specimen to the weight of an equal volume of water. If a mineral has a specific gravity of 1, it has the same weight as water. A rock has a higher specific gravity than a piece of wood of the same volume. This is why the wood (*less than 1*) floats and the rock (*greater than 1*) sinks in water. Likewise, different rocks of the same volume will have different weights.

Finding specific gravity is easy to do if you can weigh the rock while it is suspended in water and again while it is out in the air. (*The chemistry teacher at your local high*

school may have a scale similar to the one in the diagram.) Specific gravity is figured by the following formula.

$$\frac{\text{air weight}}{\text{air weight} - \text{weight in water}}$$

EXAMPLE: If the dry weight of a rock is 18.7 grams and the weight in water is 15 grams, use the following formula:

$$\frac{18.7}{18.7 - 15} = \frac{18.7}{3.7} = 5.05 \text{ specific gravity}$$

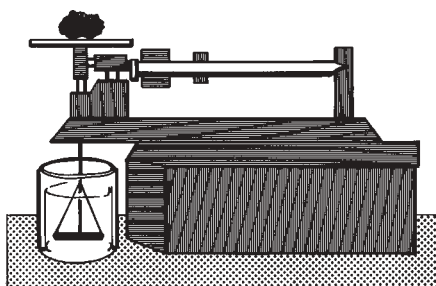

Cleavage

Many minerals will split or break along certain definite lines or planes of weakness. These weaker areas are closely related to the internal structure of the mineral and are often parallel to the faces (*surfaces*) of a crystal. This splitting is called cleavage.

Minerals may have one, two, three, four, or six directions of cleavage. The direction and how perfectly it splits depends on the characteristic of the particular mineral. Minerals that break easily along planes of weakness will have a shiny surface where the break occurs. Cleavage is important information in identifying minerals.

Since calcite is easily found in Kentucky, it would be a good mineral for experimentation.



Galena is a silver-gray metallic mineral and an important lead ore. It is formed of heavy, brittle masses of cubic crystals. It has a hardness of a 2.5 and a specific gravity of 7.3 to 7.6.

Acid Test

There are several ways to test rocks for acidity. One easy test is to put a couple of drops of vinegar on a piece of limestone. Notice that the rock begins to bubble and hiss. This weak acid is reacting with the calcium carbonate (CaCO_3) to form calcium chloride (CaCl_2), water (H_2O), and carbon dioxide (CO_2). If you put vinegar on a piece of pyrite (fool's gold), it will release a gas that smells like rotten eggs called hydrogen sulfide (H_2S). Most other minerals will not show these effects.

Magnetism

A few minerals, such as magnetite (*lodestone*) and meteorites, will attract iron or nickel. These magnetic minerals are rare in Kentucky. If you find a rock that has this property, you may have found a meteorite or a furnace product. Furnace products, sometimes called slag, are what is left over after a metal, such as iron, has been extracted from an ore. Slag is often used as gravel on railroad lines.

A Special Find... Crystals!

When you begin to collect rocks it probably will not be long before you find your first crystal. Crystals are special!

Minerals that form crystals will always form the same type of crystal. Two crystals of the same mineral may be of different sizes, but both will have the same number of sides and the same number of degrees in the same angles. By deciding the shape of the crystal, you can narrow the possibilities of its identity.

Activity

Check out your salt and sugar! Lay two crystals of salt and two of sugar on a piece of plain paper. Examine their crystalline shapes with a magnifying glass. What is their shape?

The most perfect crystals will be the smaller ones, so you may want to purchase a small magnifying glass to see them better. You may notice that crystals sometimes break up light into the different colors of the rainbow.

Isometric Crystals— Equal Measure

Study the following illustrations of various cubic forms with mineral examples.

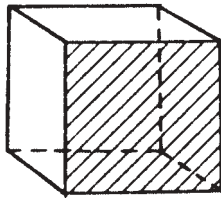

Cube

(six equal area faces)

EXAMPLE: Halite (table salt)

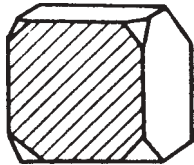

Cube with octahedral modification

(small corner cut off cube)

EXAMPLE: Sylvite

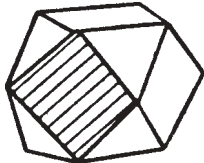

Cube with octahedral modification

(14 faces; most of corners cut off cube)

EXAMPLE: Copper

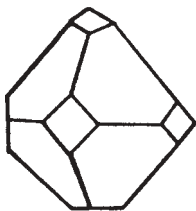

Cube with octahedral modification

(14 faces; most of the corners cut off cube)

EXAMPLE: Copper



This calcite has "dogtooth" or flat hexagonal crystals with excellent cleavage. Calcite may be colorless or white, but its impurities show yellow, orange, brown, or green. Calcite is found in limestone where large crystals may form in veins or voids.



This fluorite crystal is the same rock as the calcite crystal shown above but turned over to the other side. Fluorite is calcium fluoride, while calcite is calcium carbonate. Each may form in the same carbonate (limestone) rock within cavities or veins. Both are nonmetallic. Fluorite occurs as clear cubes with purple or other colors. This specimen is pale yellowish.

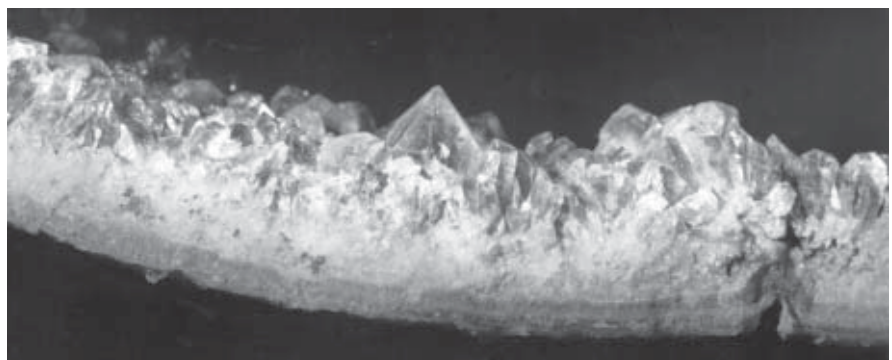

Ferric iron caused the hues of purple and violet in this transparent quartz crystal called amethyst. Amethyst is found in quartz geodes and is a nonmetallic mineral.

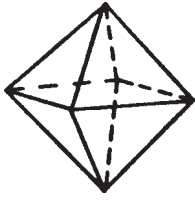

Octahedron
(8 faces; all corners cut off cube)
EXAMPLE: Fluorite

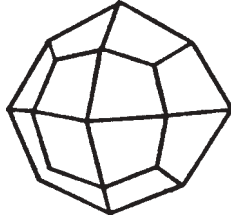

Trapezohedron
(24 faces, each with 4 sides)
EXAMPLE: Analcite

Hexagonal Crystals— Six Sides

Study the following illustrations of various hexagonal forms with mineral examples.

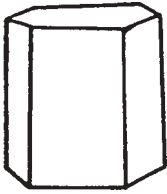

Prism
EXAMPLE: Apatite



Flat Hexagonal Prism
EXAMPLE: Nepheline

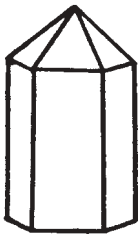

Hexagonal Pyramid
(one pyramid)
EXAMPLE: Zincite

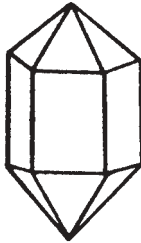

Hexagonal Bipyramid
(2 pyramids)
EXAMPLE: Quartz

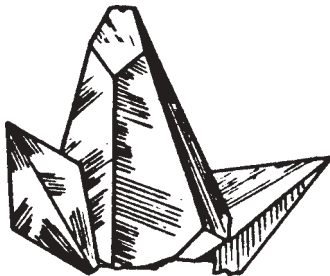
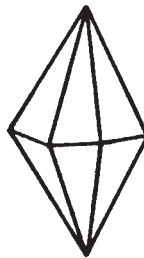

Hexagonal Scalenohedron
(unequal sides)
EXAMPLE: Siderite

Rocks That Glow in the Dark... Fluorescence and Phosphorescence

Some rock collectors collect specimens which “fluoresce” or “phosphoresce.” When an invisible ultraviolet light (*sometimes called a black light*) is shined on certain types of rocks, the light rays will be changed to colors that can be seen. Minerals that do this are said to be “fluorescent.”

The beautiful, vivid colors are often very different from the natural color of the rock. If the specimen continues to glow for a while after the ultraviolet light has been removed, the specimen is said to be “phosphorescent” (like the luminous dial on a watch).

Fluorescence is not very common, but phosphorescence is even rarer. Some locations like Franklin, New Jersey, are well known for their fluorescent minerals.

Uranium materials fluoresce, as do tungsten and some zinc ores and minerals. Some minerals may fluoresce because of impurities. Other minerals will fluoresce from one location but not from another. Because of their beauty, the search for fluorescent minerals is exciting, but serious study is difficult and you may have to work at night.

Portable quartz lamps that produce ultraviolet light can be purchased from geology supply catalogs or from rock shops. Use caution with black light. Do not stare directly at the light source.

So You Want to Do More... Advanced Activities

Try Lapidary Work

A lapidary is someone who cuts, polishes, or engraves precious stones. It can take years of work to become an excellent gem cutter. Not all rocks and minerals are suitable for cutting or polishing. If you are interested in this activity and are not able to find suitable material to work with, you can purchase rough material or partly worked "blanks" from rock shops.

The equipment needed is relatively simple and not too expensive. Cutting a hard material such as agate requires a diamond wheel powered by an electric motor. Because of the speed of the blade and the danger of flying chips, this is a dangerous piece of equipment and should be operated only by someone with experience. It is easiest to learn a skill by working and studying with an experienced person.

Polish Your Stones

If you are interested in lapidary work, you will need a tumbler for polishing stones (*rocks and minerals*). There are many types available for purchase from rock and mineral shops, or you can make one from an electric motor, some pulleys, lumber, and other spare parts. Check reference books in your library, bookstore, or hobby shop.

Putting It All Together... Displaying Your Collection

A bucket piled to the top with rocks is not a good way to display a collection. Each specimen should be displayed so it can be seen and compared to others. A bookshelf is fine unless you plan to enter your collection in 4-H competition. For this, you will need a box that is relatively large but shallow. To build your own display box, contact the industrial arts teacher at your school, the State 4-H Office, or your 4-H agent or leader for help.

Boxes for the state fair should be between 16" x 22" x 3½" and 20" x 24" x 3½". Place the rocks so that the sides of the box are the 16" (to 20") dimension and the front and back of the box are the 22" (to 24") dimension. Use a plexiglass cover that can be easily removed for judging. If you use hinges, place them on the side or make them fit flush so that the box will be level.

If you use a fabric liner, such as felt or velveteen, glue it in the box with fabric glue (available from any store that sells sewing items). Since the purpose of the box is to make the display easy to move,

the rocks must be glued firmly to the bottom of the box. Allow the glue to dry at least 24 hours before testing its hold.

Preparing Your Rocks for Exhibit

O.K., you rock hounds, **remember this!** When you mount your rocks for exhibit, you will have to renumber them. That is, you will not use the field number you placed on the rock when you found it. Follow this procedure:

1. Decide which rocks from your collection you want to exhibit. Set these aside from the rest of your collection.
2. Pull the field identification cards for these rocks from your file.
3. Decide how you want to place your rocks in the box. Place the heaviest rocks at the bottom of the box. (Remember, your box will be tilted up for display.) Whenever possible, group specimens by types. For example, place igneous rocks together, sedimentary together,

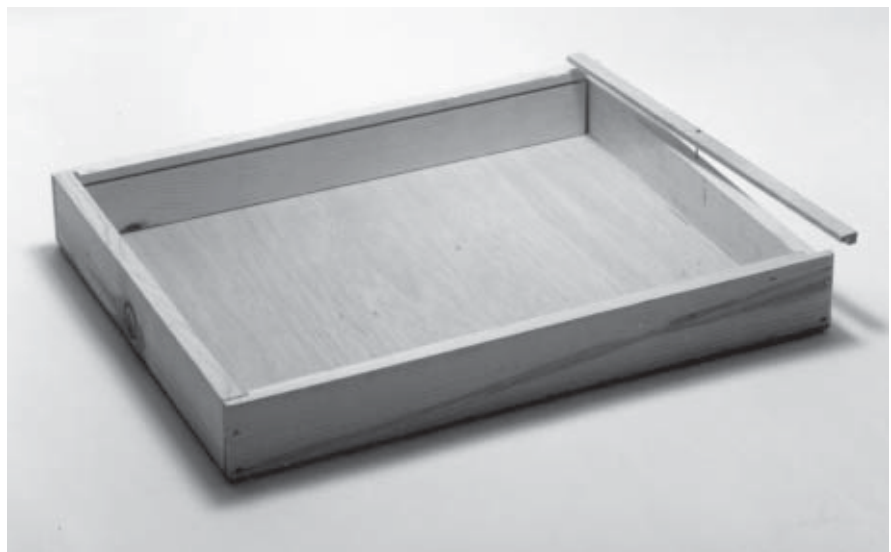

The geology box you build or purchase should look like this one. Notice the grooves cut for inserting a plexiglass top. Also note the edge that is nailed on after your collection is complete and the plexiglass is in place.

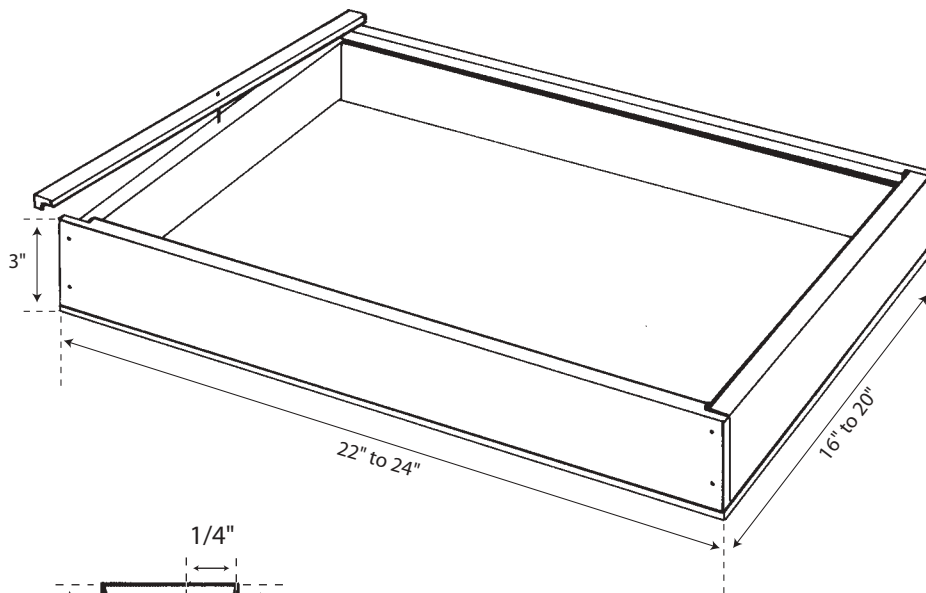

specimen in your collection. You can get labels from your 4-H agent or leader. Place a number on the label to match the one on the specimen. Then fill out the rest of the information from your field identification card. In the space for "Where," give the origin of the rock. Tell where the rock was found, not where it was purchased. If you buy at a shop, the owner can tell you the origin of the rock.

- Next, be sure to update your field identification card. Write the exhibit number of the rock on the card. This way you can keep your field identification card with all the correct information about when and where you found the rock in the file even though the rock no longer has the field identification number.

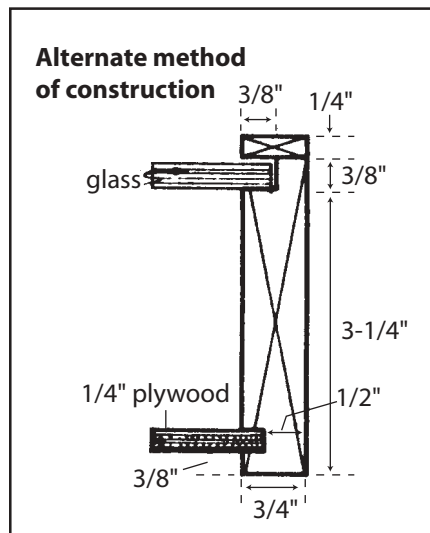
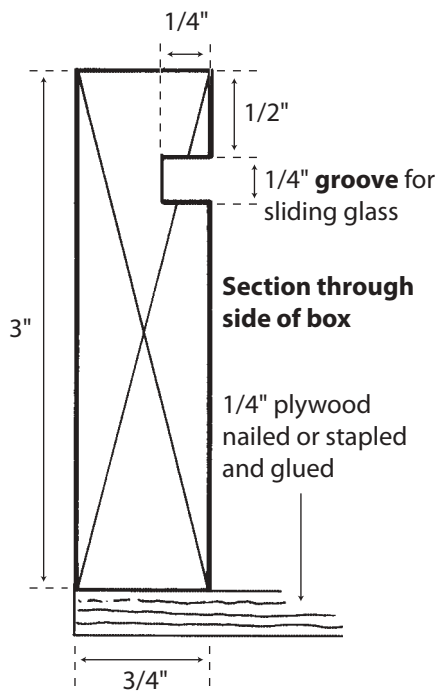

crystal rocks together, and metamorphic together. This may not always be possible since you will be placing the heavier rocks at the bottom. Decide exactly how you want to place them before you start to glue them in.

- When you have decided the order in which to exhibit your rocks, you need to renumber the rocks so they will be in the box in numerical order. This is important, so read these

instructions very carefully. Paint over the field identification number with white enamel; allow the paint to dry. Then renumber the rocks numerically as they will be placed in the box. The smallest rocks will have the lowest numbers because they will be nearest the top of the box.

- Next, prepare the geology identification label for each

10.

Name of Rock FERN/Fossil

Type of Rock Sedimentary

Circle Whether Found or Purchased

Where CLAY County

Mineral Content SHALE

Common Use COLLECTIONS

DON'T FORGET to talk to your 4-H agent about the different types and sizes of collections that will be accepted at your county fair or the Kentucky State Fair.



This 4-H geology collection is a good example of a project to enter for competition.

Exciting Places to Visit in Kentucky

State and national parks are great for viewing rock formations and finding interesting rocks, but you cannot collect rocks in these parks without written permission from the park ranger or superintendent. Because rock collecting is generally not allowed at these parks, they are good places for you to travel to see rock formations that have been disturbed very little.

Natural Bridge State Park and Red River Gorge are excellent places to see natural sandstone bridges. There are many fossils, including coral, along the Red River. There are also a couple of sites in the gorge that show layers of sediment deposited when the area was under water.

Mammoth Cave National Park is the largest cave system in the world. You can see limestone and many calcium minerals.

Cumberland Falls State Park has a large waterfall, an excellent example of the sharp drop in the elevation of a river that causes a waterfall. There also has to be a harder layer of rock in the riverbed along the upper part of the river. Water is one of the strongest forces in nature that breaks down rocks and moves soil from one location to another.

The Kentucky River offers an amazing view back in history where the river has cut a deep channel through the rock. Raven Run, a nature sanctuary outside Lexington, has an excellent overlook of the Kentucky River Palisades. It is along the Kentucky River between Frankfort and Boonesboro that you will find the oldest rocks in the state. Some are as old as 450 million years—formed long before the dinosaurs roamed the earth! You will find similar views of history in other rivers, streams, and creeks.

Road cuts offer a more limited view of the rock layers, but these rocks are less weathered than those along riverbanks. The most common rocks found in road cuts are sandstone, siltstone, shale, coal, and limestone. Kentucky has many excellent road cuts all over the state, including Highway 119 in Letcher County where extensive road cuts expose different strata.

The Outer Bluegrass is known for its large deposits of fossil shells, corals, and other animals that lived here when warm shallow seas covered this area 430 million years ago. They are best preserved in limestone. Many towns took their names from rocks and minerals of the surrounding areas. Maysville was once called Limestone.

Glacial deposits are not too common, but there are a few in the area just south of Cincinnati. However, it was the Ohio River that carried away much of the silt and melted ice. Occasionally, ice floes blocked the Licking, Kentucky, and Salt rivers, causing local flooding and lake-bottom sediments in some areas.

The Falls of the Ohio River at Louisville has been declared a nature sanctuary, and while you cannot collect there, you may be able to see some fossil coral.

Greenup and Estill counties once had a small iron industry. The early settlers used coal, limestone, and a low-grade iron ore to make the iron that they needed. There was also some ironmaking in the Land Between the Lakes region in Western Kentucky. At one time Kentucky was the third largest iron-producing state.

Big Bone Lick State Park is unique because of its salt-sulfur springs and deposits of fossil bones. This was the first collecting area for fossil bones in North America.

See Rocks and Minerals in Kentucky Museums

- Audubon State Park Henderson
- Berea College Department of Geology Berea
- Bernheim Forest Clermont
- Cumberland College Department of Geography Williamsburg
- Eastern Kentucky University Department of Geology Richmond
- Georgetown College Department of Chemistry Georgetown
- Kentucky Historical Society—Old Capitol Building Frankfort
- Louisville Museum of Science and Industry Louisville
- Mammoth Cave National Park Edmonson County
- Morehead State University College of Science
and Mathematics Morehead
- Murray State University Department of Chemistry and Geology Murray
- Transylvania University Department of Geography Lexington
- Union College Department of Chemistry Barbourville
- University of Kentucky Department of Geology—
Bowman Hall Lexington
- University of Kentucky Geological Survey—
Mineral Industries Building Lexington
- University of Louisville Department of Geology Louisville
- Western Kentucky University Department of Geology Bowling Green

More Help Is Available...

If you are interested in specific information about the geology of Kentucky, the Kentucky Geological Survey may have just what you need. The Kentucky Geological Survey is a research and service department at the University of Kentucky. It shares with the university more than a century of services to the commonwealth.

This office does research on the geology of Kentucky and its mineral resources and provides the results to the public. It also cooperates with the U.S. Geological Survey on two other statewide programs: the investigation of water resources and the continuing revision of topographic mapping. In addition, it cooperates with the United States Bureau of Mines.

In addition to the publications available to the public, the Kentucky Geological Survey has an extensive file of materials. These include geological maps of each “quadrangle” in Kentucky, county maps, topographic maps, maps of most of the wells in Kentucky, and a number of unpublished maps and reports. It will

help you purchase a geologic map of your home county to have as a reference. The files may be inspected at the Survey office from 8 a.m. to noon and 1 p.m. to 4:30 p.m. Monday through Friday. The office is closed during the noon hour.

Publications may be ordered from:

Kentucky Geological Survey

311 Breckinridge Hall
University of Kentucky
Lexington, KY 40506-0056
Phone: (859) 257-3896

Suggested General References

- The Geologic Story of Kentucky:*
Kentucky Geological Survey, ser. 2, 8, Special Publications 9, University of Kentucky, 311 Breckinridge Hall, Lexington, Kentucky 40546-0056.
- Geology Golden Guides.* Racine, Wisconsin: Western Publishing Company, Department M, 1220 Mound Avenue, 53404.
- Loomis, Frederick B. *Field Guide to Common Rocks and Minerals.* New York: G.P. Putnam and Sons, 1948.

- Plough, Frederick H. *Field Guide to Rocks and Minerals.* Boston: Houghton Mifflin Company, 1976.
- Shaffer, P.R. and H.S. Zim. *Fossils.* New York: The Golden Press, 1962.
- Shaffer, P.R. and H.S. Zim. *Rocks and Minerals: A Guide to Familiar Minerals, Gems, Ores, and Rocks.* New York: Simon and Schuster, 1957.
- Spock, Leslie E. *Guide to the Study of Rocks.* New York: Harper's, 1953.

Ideas for Demonstrations & Speeches

- The differences between rocks, minerals and fossils.
- The tools and equipment necessary to begin collecting rocks.
- How to clean, identify, and mount rocks for a collection.
- How fossils are preserved.
- Explain how coal is formed and/or mined.
- The glacial period on earth.
- How Mammoth Cave was formed.
- How we use rocks in our homes (or business or town, etc.).
- Come up with some neat ideas of your own! (You may want help from your leader.)

Citizenship & Leadership Activities

- Serve as a junior leader for a younger group of 4-H'ers who are interested in a geology project.
- Help with a field trip for younger geology project group members to museums and other suggested places.
- Practice good citizenship rules when collecting rocks on private property or visiting state and national parks.
- Report interesting geological experiences or observations to your 4-H geology project group or club.
- Take your club to a state or national park to help with a clean-up operation. (Have your leader make arrangements first.)

4-H Geology Project Record



Name _____ Birth Date _____

Address _____
Street & Number/Rural Route Town Zip

School _____ Grade _____ County _____

Number of Years in 4-H _____ Number of Years in Geology _____

1. Describe your main objective or goal (s) for this project. _____

2. Were you successful in reaching your goal (s)? Yes _____ No _____
 If no, why? _____

3. List the activities that helped you reach your goal (s). _____

4. List demonstrations/illustrated talks/speeches given about this project.

Date	Title	Audience to Whom Presented	Number of People	Award or Recognition

5. I participated in the following leadership/citizenship activities related to this project.

Type of Activity	Where	Number of People Involved	Date

